



BOSCH



ACCESSORIES HARDWARE PRICE LIST 2021

The best your tool can get. Bosch Professional Accessories.

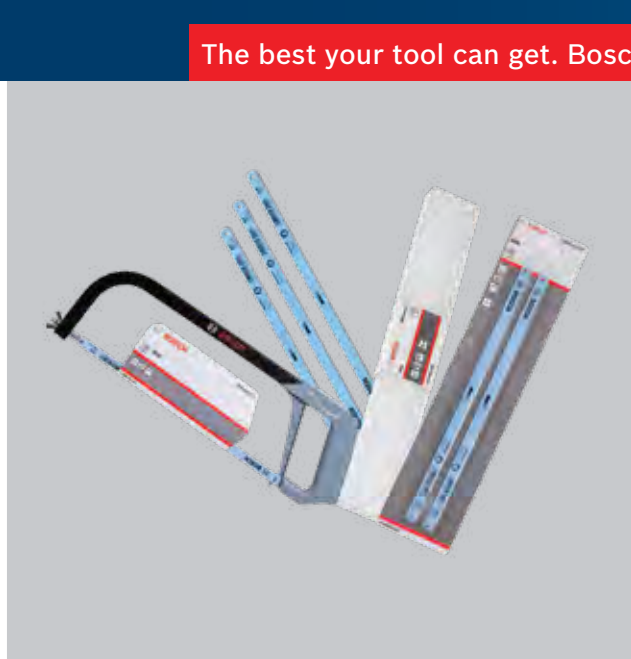

Bosch Accessories guarantee your success

Bosch is the leading manufacturer of accessories for power tools. The rich tradition of manufacturing has been built on excellent quality and customer-centricity. Today, Bosch is the top supplier of an extensive and universal range of accessories for all applications, target groups and all brands of power tools. With more than 8000 products, Bosch offers everything from a single source – a complete range in outstanding product quality.



Innovation leader with over 130 years of tradition

Bosch is the leading name in the field of modern power tools with its cutting-edge technologies for the past 132 years. Powered with its own research and development team, Bosch aims to develop innovative accessories for all applications to promote efficient working with reduced labour. Bosch has also registered several hundred patents with its innovative applications and has transformed the accessories sector with its brilliance. Experience the best. Always.



CONTENTS

HACKSAW

Hacksaw Blade and Frame	9
-------------------------	---

ROUTER BIT SETS

New! Tungsten Planer Knife	10
New! Router Bit Sets	10

HANDHELD TACKER

New! Handheld Tacker HT 8	11
New! Handheld Tacker HT 14	11

COATED ABRASIVES

Hand Sanding Sheet - Wood & Wall	16
Hand Sanding Sheet - General Purpose	16
Hand Sanding Sheet - Automotive	16
Velcro Sheet - 8 Holes	16
Velcro Sheet - 6 Holes	17
New! Fibre Discs - Eco for Wood	17
Fibre Sanding Discs - Expert for Wood	17
New! Eco for Flap Disc	17
Flap Discs - Normal Pack	17
Flap Discs - Promo Pack	18
Non-woven Pad	18
Non-woven Roll	18
Foam - Block & Pad	18
New Rolls - Sia 2906 Flexible	18
New Rolls - Sia 2909 Rigid	18

CIRCULAR SAW BLADES

Eco for Wood, Multimaterial & Aluminium	21
New! Eco for wood- 25 pc promo pack	21
New! CoolteQ - 12 Teeth	21
Expert Series - 184 mm	21
Expert Series - 235 mm	21
Expert Series - 254 mm	21
Expert Series - 305 mm	21
Expert Series - 355 mm	21

CUTTING AND GRINDING

Cutting Discs - Best for Metal	25
Cutting Discs - Standard for Metal	25
New! Cutting Discs - Standard for Metal	25
New! Eco Cutting Discs - Standard for Metal	25
New! Eco Cutting Discs - Standard for Inox	25
Expert for Heavy Metal in Cutting and Grinding	25
Cutting Discs - Standard for Inox	25
Cutting Discs - Expert for Inox	25
Grinding Discs - Best for Metal	25
New! 4 Inch Grinding Disc - Expert for Metal Grinding	26
Grinding Discs - Standard for Metal	26
Grinding Discs - Expert for Inox	26
Grinding Discs - Expert for Metal	26
Expert for V - Grinding Discs	26
Grinding Discs - Metal	26
Grinding Discs - Inox	26
Bench Grinding Wheel	26
Grinding Stone, Cylindrical, Medium-hard	26
New! 7 Inch Cast Iron Grinding Wheel	26
Wire Brushes	26

SCREWDRIVING BITS

Double Ended Bits	29
Standard for Universal - Double Ended Screwdriver Bits	29
Sockets for Impact Wrenches	29
New! Impact Double Ended Screwdriving Bits	29

METAL DRILL BITS

New! Metal Drill Bits - Twist Drill PointTeQ Range	33
Metal Drill Bit Set - HSS-G	36
Metal Drill Bits Set	38

WOOD DRILL BITS

Wood Spade Bits - Clean Cut Range	39
-----------------------------------	----

DRILLING

New! SDS Plus-1 Drill Bit Set	42
SDS Plus-1 Hammer Drill Bits	43
Masonry Bit	
Masonry Drill Bit - Cyl-1	45
Masonry Drill Bit - Cyl-2	45
SDS Max-9 Breakthrough	45

DIAMOND CUTTING, GRINDING & DRILLING

Diamond Cutting Discs - Expert for Universal	48
Diamond Cutting Discs - for Tile Cutting	48
Diamond Cutting Discs - for Stone Cutting	48
Diamond Cutting Discs - Expert for Universal	48
Diamond Cup Wheel - Expert for Universal Turbo	48
New! Eco Range 5 Inch Concrete Grinding Wheels	48

HOLESAWING

HSS Bi-metal Holesaws for Standard Adapters	50
Accessories for Standard Bi-metal Holesaws	50
Hole Cutters	50
Holesaw Sets	50

JIGSAW BLADES

Jigsaw Blades	52
---------------	----

MIXED SETS

New! Pick and Click	55
New! X-34 Ti Mixed Set - 34 pcs	56
New! Bosch DIY Starter Kit - 73 pcs	56
New! Mixed Sets	57
New Handtool Sets	57
Metal Drill Bit Sets - HSS-R	57
Screwdriver Bit Sets	57
X Line Titanium Sets	58

QUALITY HIT, BUDGET FIT

CoolteQ CSB 12 Teeth

Innovative CoolteQ enables up to 10X more lifetime

NEW!



CIRCULAR SAW BLADE CoolteQ 12 Teeth



Part Number	Outer Diameter mm	Teeth	Application	Pack Quantity	List Price ₹
2608644669	110	12	Wood	1	133.90
2608644670	125	12	Wood	1	147.29

STRONGER AND TOUGHER

Bosch 14" Cutting Disc

expert  HeavyMetal 2608619394

NEW!

SUITABLE FOR STAINLESS STEEL



CUTTING DISC
Expert for Heavy Metal



Part Number	Diameter mm	Thickness mm	Pack Quantity	List Price ₹ /Piece
2608619394	355	3	25	162.54

STANDARD FOR MILD AND STAINLESS STEEL

4" Green Cutting Wheel

standard **for Metal** 2608 619 700

**NEWLY
LAUNCHED**



4" GREEN CUTTING WHEEL
Standard for Metal



Part Number	Diameter mm	Thickness mm	Pack Quantity	List Price ₹ /Piece
2608619700	105	1.2	25	16.48

LAMBSWOOL BONNET

Lambswool bonnet and polishing sponge for 7" polishers

Aggressive cut and high durability, thanks to the 100% premium twisted natural wool

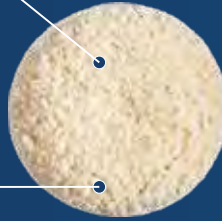

Easy polish on flat surfaces and edges, thanks to the bowl shape design



Consistent surface finishing, thanks to the high quality and even wool-planting

Quick change and good adhesion to backing plate of polisher, thanks to hook-and-loop connection



LAMBSWOOL BONNET



Part Number

Description

Pack Quantity

List Price ₹

2608621759

Lambswool Bonnet 100% twisted wool

1

624.24

NON-WOVEN PAD & ROLLS

Affordable Choice. Wide Range.



HIGH REMOVAL
meets good finish



2906 siatur

2906 siatur is an ideal hand sanding series, designed for profile sanding of radii from 5 - 10 mm and achieves good dimensional accuracy in profile sanding applications.



2909 siawood

2909 siawood is ideal for sanding in solid wood, plywood and softwood board production. Offers high stock removal rates, long life and good finish in coarse to fine sanding applications.



**BOSCH FIBRE
SANDING DISCS**
work faster, long lasting

BOSCH HAND SANDING SHEETS



General Purpose



Automotive



Wood & Wall

MIXED SETS & HANDTOOL SETS



For more details refer page 52 onwards

HACKSAW FRAME AND BLADE

BENEFITS / WHY BOSCH?

- ▶ The hacksaw BIM delivers excellent performance in handheld applications.
- ▶ Complete solutions (blade + frame) which does not lock in the cutting material at affordable price.

MATERIALS:

PVC pipes, metallic conductors, optic fiber cables, copper cable, metal sheets, nails, etc.

HACKSAW FRAME



Part Number	Description	Pack Quantity	List Price ₹ /Piece
2608003031	Hacksaw Frame	1	446.51

HACKSAW BLADES

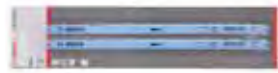

Part Number	Description	Pack Quantity	List Price ₹ /Piece
2608003027	Hacksaw 18 T blister pack	2	136.58
2608003028	Hacksaw 24 T blister pack	2	136.58
2608003029	Hacksaw 32 T blister pack	2	136.58

HACKSAW BLADES



Part Number	Description	Pack Quantity	List Price ₹ /Piece
2608003024	Hacksaw 18 T box	50*	59.88
2608003025	Hacksaw 24 T box	50*	59.88
2608003026	Hacksaw 32 T box	50*	59.88

*In the multiple of 50 only



NEW!

TUNGSTEN PLANER KNIFE

Delivers clean results on all wooden materials



BENEFITS / WHY BOSCH?

- ▶ **EXTRA LONG LIFE**
20X times longer life vs HSS planer knife with 2 cutting edges.
- ▶ **5X FASTER KNIFE CHANGE**
Notch design enables quick and easy blade hassle-free replacement.
- ▶ **FINE CUTTING**
Quality carbide cutting edges.
- ▶ **UNIVERSAL**
Fits most of 82mm portable planers in AP market with adapter.

MATERIALS: Solid wood, chipboard, MDF



Part Number	Description	Pack Quantity	List Price ₹
2608838999	Tungsten Carbide Planer Knives and Adapter set	1	762.74

NEW!

ROUTER BIT SETS

Fine cuts for a wide variety of applications

BENEFITS / WHY BOSCH?

- ▶ **Perfect starter and application set** with a great router bit assortment for any project
- ▶ **A complete selection of router bits** for most common applications in one set for a reasonable price
- ▶ **Fine finish cutting results** thanks to quality carbide cutting edges
- ▶ **Value for money** compared to buying single router bits

User group

Cabinet maker, joiner, carpenter, kitchen fitter, interior installer, boat builder, woodworking enthusiasts, construction workers

MATERIALS: Wood



BOSCH ROUTER BIT SETS



Part Number	Description	Pack Quantity	List Price ₹ /Piece
2607017466	6 Pcs Straight Bit Set 8mm shank	6	1801.78

BOSCH ROUTER BIT SETS



Part Number	Description	Pack Quantity	List Price ₹ /Piece
2607017472	15 Pcs Mixed Bit Set 8mm shank	15	4577.46

HANDHELD TACKER HT 8

Quick fastening made easy



NEW!

BENEFITS / WHY BOSCH?

- ▶ Suitable for quick fixing of fabrics, foils, insulation material, etc.
- ▶ Robust, polished steel, with padded grip and grip-lock
- ▶ Appropriate staple type 53, length of 4, 6, 8 mm

MATERIALS:

Textiles, cardboard, flat wooden slats, woven wire



HANDHELD TACKER HT 14

Quick fastening made easy



NEW!

BENEFITS / WHY BOSCH?

- ▶ Suitable for quick fixing of fabrics, roofing felt, foils, insulation materials, woven wires and for light upholstery work, etc.
- ▶ Multi-purpose tacker made of robust, polished steel, with continuously variable power adjustment, padded grip and grip-lock
- ▶ Appropriate staple type 53, length of 4, 6, 8, 10, 12, 14 mm, appropriate pin type 41, length of 14 mm

MATERIALS:

Fabrics, roof felt, foils, insulation materials, woven wires, and for light upholstery work



HANDHELD TACKER HT 8

NEW!



Part Number	Description	Pack Quantity	List Price ₹
0603038000	Handheld Tacker HT8	1	570.41

STAPLES Fine wire staples, Type 53

NEW!



Part Number	Length mm	Pack Quantity	List Price ₹
2609200291	4	1000	146.98
1609200326	6	1000	146.98
1609200365	8	1000	153.68
1609200366	10	1000	160.27
1609200367	12	1000	173.66
1609200368	14	1000	187.05

HANDHELD TACKER HT 14

NEW!



Part Number	Description	Pack Quantity	List Price ₹
0603038001	Handheld Tacker HT14	1	710.70

STAPLES Pins, type 41

NEW!



Part Number	Length mm	Pack Quantity	List Price ₹
2609200292	14	1000	307.25

COATED ABRASIVES



COLOUR FOAM ABRASIVE

An evolutional solution for hand sanding



- ### BENEFITS / WHY BOSCH?
- ▶ **EXTREMELY LONG LIFE**
Min. 4x longer life than traditional hand sanding paper.
 - ▶ **HANDY AND SUPER FLEXIBLE**
Easily adapt to shape, contour, hard to reach area. No cracking, no grain shedding.
 - ▶ **UNIQUE COLOUR CODING**
Easy to select and identify with simply 3 colours.
 - ▶ **MADE BY BOSCH PLANT IN UK**
Consistent high quality and non-hazard gradients, due to advanced SFT technology.

MATERIALS: Wood, paint, composite material, non-ferrous metal

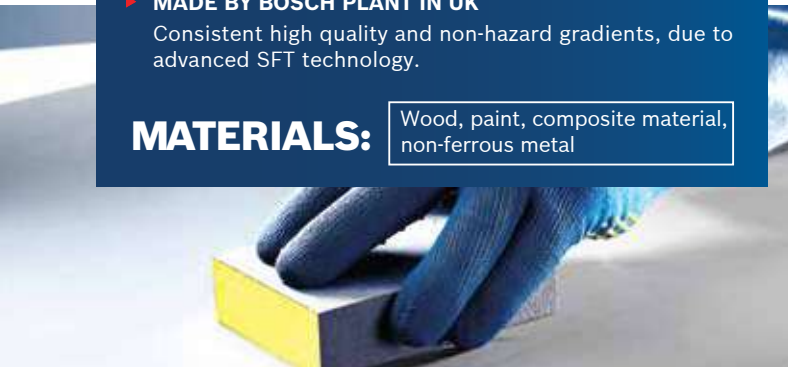

FOAM BLOCK			
Part Number	Dimensions	Pack Quantity	List Price ₹ /Piece
2608625003	69x97x26 mm Grit-Medium	250	30.90
2608625004	69x97x26 mm Grit-Fine	250	30.90
2608625005	69x97x26 mm Grit-Super Fine	250	30.90

FOAM PAD			
Part Number	Dimensions	Pack Quantity	List Price ₹ /Piece
2608625006	98x120x13 mm Grit-Medium	250	18.54
2608625007	98x120x13 mm Grit-Fine	250	18.54
2608625008	98x120x13 mm Grit-Super Fine	250	18.54



QUALITY HIT, BUDGET FIT

R420 5" Eco Fibre Sanding Disc

The best your tool can get. Bosch Professional Accessories.

Now
Available in
Vacuum
Shrink Wrap
Packaging



R420
FIBRE DISC
Eco for Wood



Part Number	Sheet Dimensions mm	Grit	Pack Quantity	List Price ₹ / Pack
2608619358	125	36	100	1747.88
2608619359	125	60	100	1623.03
2608619360	125	80	100	1604.31
2608619361	125	120	100	1604.31

X430

NEW FLAP DISC

New 10 pc pack

NEW!

X430

ECO FOR FLAP DISC

Part Number	Dimensions	Pack Quantity	List Price ₹ / Piece
2608621838	100 mm - Grit 36	10	27.55
2608621839	100 mm - Grit 60	10	27.55
2608621840	100 mm - Grit 80	10	27.55
2608621841	100 mm - Grit 120	10	27.55

**HAND SANDING SHEET
WOOD & WALL**

Part Number	Dimensions	Pack Quantity	List Price ₹ /Pack
2608621491	230 x 280 mm Grit 60	100	839.88
2608621492	230 x 280 mm Grit 80	100	839.88
2608621493	230 x 280 mm Grit 100	100	786.15
2608621494	230 x 280 mm Grit 120	100	786.15
2608621495	230 x 280 mm Grit 150	100	786.15
2608621496	230 x 280 mm Grit 180	100	786.15
2608621497	230 x 280 mm Grit 220	100	786.15
2608621498	230 x 280 mm Grit 240	100	786.15
2608621499	230 x 280 mm Grit 320	100	786.15

**HAND SANDING SHEET
GENERAL PURPOSE**

Part Number	Dimensions	Pack Quantity	List Price ₹ /Pack
2608621106	230 x 280 mm Grit 60	100	1,369.90
2608621107	230 x 280 mm Grit 80	100	1,351.70
2608621108	230 x 280 mm Grit 100	100	1,332.54
2608621109	230 x 280 mm Grit 120	100	1,344.15
2608621110	230 x 280 mm Grit 150	100	1,349.30
2608621111	230 x 280 mm Grit 180	100	1,358.57
2608621112	230 x 280 mm Grit 220	100	1,347.24
2608621113	237 x 280 mm Grit 240	100	1,349.07
2608621114	238 x 280 mm Grit 320	100	1,353.20
2608621115	239 x 280 mm Grit 400	100	1,351.86
2608621116	240 x 280 mm Grit 500	100	1,359.99
2608621117	241 x 280 mm Grit 600	100	1,361.30
2608621118	242 x 280 mm Grit 800	100	1,363.80
2608621119	243 x 280 mm Grit 1000	100	1,363.49

**HAND SANDING SHEET
AUTOMOTIVE**

Part Number	Dimensions	Pack Quantity	List Price ₹ /Pack
2608621509	230 x 280 mm Grit 60	100	1,468.14
2608621510	230 x 280 mm Grit 80	100	1,468.14
2608621511	230 x 280 mm Grit 100	100	1,468.14
2608621512	230 x 280 mm Grit 120	100	1,468.14
2608621513	230 x 280 mm Grit 150	100	1,485.50
2608621514	230 x 280 mm Grit 180	100	1,485.50
2608621515	230 x 280 mm Grit 220	100	1,485.50
2608621516	230 x 280 mm Grit 240	100	1,485.50
2608621517	230 x 280 mm Grit 320	100	1,485.50
2608621518	230 x 280 mm Grit 400	100	1,485.50
2608621519	230 x 280 mm Grit 500	100	1,485.50
2608621520	230 x 280 mm Grit 600	100	1,485.50
2608621521	230 x 280 mm Grit 800	100	1,535.03
2608621522	230 x 280 mm Grit 1000	100	1,535.03
2608621523	230 x 280 mm Grit 1200	100	1,535.03
2608621524	230 x 280 mm Grit 1500	100	1,535.03
2608621525	230 x 280 mm Grit 2000	100	1,477.27
2608621526	230 x 280 mm Grit 2500	100	1,526.03

VELCRO SHEET, 8 HOLES

Part Number	Sheet Dimensions mm	Grit	Pack Quantity	List Price ₹ /Piece
2608601652	125	60	50	13.58
2608601653	125	80	50	13.63
2608601654	125	100	50	13.55
2608601655	125	120	50	13.41
2608601656	125	150	50	14.49
2608601657	125	180	50	15.44
2608601658	125	220	50	13.96
2608601659	125	240	50	13.15
2608601660	125	280	50	13.15
2608601661	125	320	50	13.63
2608601662	125	400	50	13.63
2608601663	125	500	50	14.94
2608601664	125	600	50	14.11

VELCRO SHEET, 6 HOLES



Part Number	Sheet Dimensions mm	Grit	Pack Quantity	List Price ₹ /Piece
2608601638	150	60	50	15.83
2608601639	150	80	50	15.83
2608601640	150	100	50	15.83
2608601641	150	120	50	15.83
2608601642	150	150	50	15.83
2608601643	150	180	50	15.83
2608601644	150	220	50	15.83
2608601645	150	240	50	15.83
2608601646	150	280	50	15.83
2608601647	150	320	50	15.83
2608601648	150	400	50	15.83
2608601649	150	500	50	15.83
2608601650	150	600	50	15.83

SANDING SHEETS FOR RANDOM ORBIT SANDERS, Best for Wood, 125 mm diameter, 8 holes



Part Number	Sheet Dimensions mm	Grit	Pack Quantity	List Price ₹
2608607491	125	40	50	1,670.66
2608607492	125	60	50	1,276.05
2608607493	125	80	50	1,132.36
2608607494	125	120	50	1,114.37
2608607495	125	180	50	1,133.97
2608607496	125	240	50	1,417.60
2608607497	125	320	50	1,320.65

SANDING SHEETS FOR RANDOM ORBIT SANDERS, Best for Wood, 150 mm diameter, 6 holes



Part Number	Sheet Dimensions mm	Grit	Pack Quantity	List Price ₹
2608607498	150	40	50	1,704.10
2608607499	150	60	50	1,476.39
2608607500	150	80	50	1,387.50
2608607501	150	120	50	1,362.91
2608607502	150	180	50	1,326.74
2608607503	150	240	50	1,429.58
2608607504	150	320	50	1,529.36

R420
FIBRE DISC
Eco for Wood

NEW!



Part Number	Sheet Dimensions mm	Grit	Pack Quantity	List Price ₹ /Pack
2608619358	125	36	100	1,747.88
2608619359	125	60	100	1,623.03
2608619360	125	80	100	1,604.31
2608619361	125	120	100	1,604.31

FIBRE SANDING DISC
Expert for Wood

Part Number	Sheet Dimensions mm	Grit	Pack Quantity	List Price ₹ /Piece
2608601577	100	24	25	22.45
2608601578	100	36	25	31.12
2608601579	100	40	25	18.33
2608601580	100	60	25	25.15
2608601581	100	80	25	23.78
2608601582	100	100	25	15.97
2608601583	100	120	25	23.50
2608601584	125	24	25	34.60
2608601585	125	36	25	33.45
2608601586	125	40	25	19.64
2608601587	125	60	25	25.55
2608601588	125	80	25	23.97
2608601589	125	100	25	24.10
2608601590	125	120	25	23.71
2608601591	180	24	25	65.88
2608601592	180	36	25	57.98
2608601593	180	40	25	42.94
2608601594	180	60	25	53.80
2608601595	180	80	25	49.69
2608601596	180	100	25	40.13
2608601597	180	120	25	49.03

X430
ECO FOR FLAP DISC

NEW!



Part Number	Dimensions	Pack Quantity	List Price ₹ /Piece
2608621838	100 mm - Grit 36	10	27.55
2608621839	100 mm - Grit 60	10	27.55
2608621840	100 mm - Grit 80	10	27.55
2608621841	100 mm - Grit 120	10	27.55

X433
FLAP DISC

Part Number	Disc Diameter mm	Bore Diameter mm	Grit	Pack Quantity	List Price ₹ /Piece
2608601684	180	22-23	40	10	128.52
2608601685	180	22-23	60	10	132.72
2608601686	180	22-23	80	10	132.72
2608601687	180	22-23	120	10	132.72

X433
FLAP DISC
Promo Pack



Part Number	Dimensions	Pack Quantity	List Price ₹ / Pack
2608619333	100 mm Grit 36	11	336.19
2608619334	100 mm Grit 60	11	336.19
2608619335	100 mm Grit 80	11	336.19
2608619336	100 mm Grit 120	11	336.19
2608619347	125 mm Flap Disc Grit 36	11	649.27
2608619348	125 mm Flap Disc Grit 40	11	649.27
2608619349	125 mm Flap Disc Grit 60	11	649.27
2608619350	125 mm Flap Disc Grit 80	11	649.27
2608619351	125 mm Flap Disc Grit 120	11	649.27

NON-WOVEN PAD



Part Number	Description	Pack Quantity	List Price ₹
F03E014K8G	152x229 mm Grit-Very Fine	1	22.12
F03E014K8J	152x229 mm Grit-Medium	1	33.90

NON-WOVEN ROLL



Part Number	Dimensions	Pack Quantity	List Price ₹ /Piece
F03E014K8H	150x20000 mm Grit-Very Fine	1	1938.84
F03E014K8K	150x20000 mm Grit-Medium	1	2833.26

FOAM BLOCK



Part Number	Dimensions	Pack Quantity	List Price ₹ /Piece
2608625003	69x97x26 mm Grit-Medium	250	30.90
2608625004	69x97x26 mm Grit-Fine	250	30.90
2608625005	69x97x26 mm Grit-Super Fine	250	30.90

FOAM PAD



Part Number	Dimensions	Pack Quantity	List Price ₹ /Piece
2608625006	98x120x13 mm Grit-Medium	250	18.54
2608625007	98x120x13 mm Grit-Fine	250	18.54
2608625008	98x120x13 mm Grit-Super Fine	250	18.54

NEW ROLLS SIA 2906 FLEXIBLE



Part Number	Dimensions	Pack Quantity	List Price ₹
F03E02G1FK	102x50 mm Grit 60	1	1489.23
F03E02G18W	102x50 mm Grit 80	1	1489.23
F03E02G18X	102x50 mm Grit 100	1	1489.23
F03E02G18Y	102x50 mm Grit 120	1	1489.23
F03E02G1FL	102x50 mm Grit 180	1	1489.23
F03E02G1FM	102x50 mm Grit 220	1	1489.23
F03E02G1FN	102x50 mm Grit 320	1	1599.54

NEW ROLLS SIA 2909 RIGID



Part Number	Dimensions	Pack Quantity	List Price ₹ /Piece
F03E02G1FP	102x50 mm Grit 36	1	1489.23
F03E02G1FR	102x50 mm Grit 40	1	1489.23
F03E02G1FS	102x50 mm Grit 60	1	1489.23
F03E02G199	102x50 mm Grit 80	1	1489.23
F03E02G1FT	102x50 mm Grit 100	1	1489.23
F03E02G19A	102x50 mm Grit 120	1	1489.23
F03E02G19C	102x50 mm Grit 180	1	1489.23
F03E02G1FU	102x50 mm Grit 220	1	1489.23
F03E02G1FV	102x50 mm Grit 320	1	1489.23



CIRCULAR SAW BLADES



CoolteQ 12 Teeth CSB

Innovative CoolteQ enables lifetime.
Comes in the blister packing.

NEW!

Less heat, long lifetime

coolteQ design: special arrangement for heat emission holes

Thanks to the innovative design of holes in the body, which dissipates heat effectively during cutting

Long lifetime

Good carbide

Due to better grade of carbide tips and well ground teeth

Stable cut, safe use

Innovative design: Special anti-kickback structure for hump tooth shoulder

Best designed shape and size avoids anti-kickback during cutting, which ensures stable cut and safe using

Fast cut, good quality of cut

Optimized geometry

The optimized tooth count ensures a fast cut, the gullets release dust properly which avoids sticking, thus, delivers a good QoC

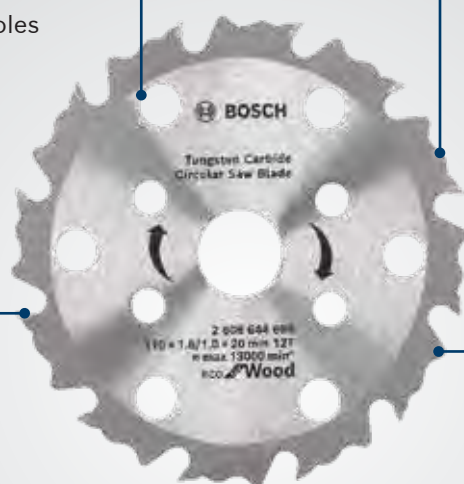

CIRCULAR SAW BLADE CoolteQ 12 Teeth CSB



Part Number	Outer Diameter mm	Teeth	Bore Size mm	Pack Quantity	List Price ₹
2608644669	110	12	20.0	1	133.90
2608644670	125	12	20.0	1	147.29

CIRCULAR SAW BLADES
 Eco for Wood, Aluminium &
 Multimaterial

Part Number	Outer Diameter mm	Number of Teeth	Bore Size mm	Reduction Ring	Pack Qty.	List Price ₹
-------------	-------------------	-----------------	--------------	----------------	-----------	--------------

Wood

2608644660	110	30	20.0	—	25	4150.92
2608644661	110	40	20.0	—	25	4900.00
2608644673	125	30	20.0	—	25	4356.90
2608644674	125	40	20.0	—	25	5314.80
2608644278	180	40	25.4	20	1	480.68
2608644279	180	60	25.4	20	1	554.09
2608644280	200	40	30.0	20	1	552.70
2608644281	200	60	30.0	20	1	651.17
2608644293	300	80	30.0	25.4	1	1902.51

Aluminium

2608644294	250	100	25.4	20	1	1633.78
2608644295	300	120	30.0	20	1	2390.64

Multimaterial

2608644276	110	40	20.0	—	1	254.95
2608644277	125	40	20.0	—	1	276.79

CIRCULAR SAW BLADES
 CoolteQ - 12 Teeth CSB -
 10X Life with Fast Cut

NEW!

Part Number	Outer Diameter in mm	Number of Teeth	Bore Size mm	Pack Quantity	List Price ₹
-------------	----------------------	-----------------	--------------	---------------	--------------

Wood

2608644669	110	12	20.0	1	133.90
2608644670	125	12	20.0	1	147.29

CIRCULAR SAW BLADES
 Expert Series - 184 mm

Part Number	Outer Diameter in mm	Number of Teeth	Bore Size mm	Pack Quantity	List Price ₹
-------------	----------------------	-----------------	--------------	---------------	--------------

Wood

2608642977	184	16	20.0	1	493.19
2608642979	184	24	20.0	1	536.24
2608642980	184	40	20.0	1	628.12
2608642981	184	60	20.0	1	753.13
2608642982	184	24	25.4	1	491.88
2608642984	184	40	25.4	1	604.40
2608642985	184	60	25.4	1	735.63

Multimaterial

2608642193	184	60	20.0	1	969.29
2608642194	184	60	25.4	1	972.25

Speed for wood

2608643047	184	20	20.0	1	644.65
2608643048	184	20	20.0	1	823.74

CIRCULAR SAW BLADES
 Expert Series - 235 mm

Part Number	Outer Diameter in mm	Number of Teeth	Bore Size mm	Pack Quantity	List Price ₹
-------------	----------------------	-----------------	--------------	---------------	--------------

Wood

2608642998	235	60	25.0	1	1114.64
------------	-----	----	------	---	---------

Multimaterial

2608642197	235	80	25.0	1	1136.59
------------	-----	----	------	---	---------

CIRCULAR SAW BLADES
 Expert Series - 254 mm
 For Mitre saws and Table saws

Part Number	Outer Diameter in mm	Number of Teeth	Bore Size mm	Pack Quantity	List Price ₹
-------------	----------------------	-----------------	--------------	---------------	--------------

Wood

2608644341	254	32	30.0	1	2430.78
2608643007	254	40	30.0	1	982.88
2608643008	254	60	30.0	1	1200.59
2608643010	254	100	30.0	1	1615.87

Multimaterial

2608642198	254	100	25.4	1	1681.11
2608642199	254	120	25.4	1	2156.07
2608642202	254	100	30.0	1	1456.73
2608642203	254	120	30.0	1	1832.31

CIRCULAR SAW BLADES
 Expert Series - 305 mm
 For Mitre saws and Table saws

Part Number	Outer Diameter in mm	Number of Teeth	Bore Size mm	Pack Quantity	List Price ₹
-------------	----------------------	-----------------	--------------	---------------	--------------

Wood

2608643021	305	40	25.4	1	1334.77
2608643024	305	40	30.0	1	1341.85
2608643025	305	60	30.0	1	1577.98
2608643026	305	80	30.0	1	1912.89
2608643027	305	100	30.0	1	2236.29
2608643028	305	120	30.0	1	2625.74

Multimaterial

2608640982	305	80	30.0	1	1848.71
2608642206	305	100	25.4	1	2543.90
2608642207	305	120	25.4	1	2667.22
2608642209	305	100	30.0	1	2684.09
2608642210	305	120	30.0	1	3406.65

CIRCULAR SAW BLADES
 Expert Series - 355 mm
 For Mitre saws and Table saws

Part Number	Outer Diameter in mm	Number of Teeth	Bore Size mm	Pack Quantity	List Price ₹
-------------	----------------------	-----------------	--------------	---------------	--------------

Multimaterial

2608642211	355	80	25.4	1	2784.82
2608642213	355	100	30.0	1	3451.40
2608642214	355	120	30.0	1	3547.37



CUTTING AND GRINDING

14 INCH DOUBLE MESH METAL CUTTING DISC

Affordable price with high performance

NEW!



14 INCH DOUBLE MESH METAL CUTTING DISC



Part No.: 2608619382

Part Number	Diameter mm	Thickness mm	Pack Quantity	List Price ₹ /Piece
2608619382	355	3	20	150.30



Applications
Metal Cutting



Target Users
Metal Fabricator,
Construction Worker



Main User Benefits
Long Lifetime,
High Price Performance Ratio

4 INCH GRINDING DISC

Expert for Metal Grinding Disc



NEW!

4 INCH GRINDING DISCS

Expert for Metal Grinding





Part Number	Diameter mm	Thickness mm	Pack Quantity	List Price ₹ /Piece
2608619379	100	4.5	25	32.15
2608603686	100	6	25	33.62

CUTTING DISCS Best for Metal				
Part Number	Diameter mm	Thickness mm	Pack Quantity	List Price ₹
2608620674	100	1.2	50	49.83
2608620676	125	3	50	58.66
2608620677	180	3	50	84.22

CUTTING DISCS Standard for Metal				
Part Number	Diameter mm	Thickness mm	Pack Quantity	List Price ₹
2608579786	105	1.2	25	16.48
2608619786	105	1.2	25	16.48
2608619700	105	1.2	25	16.48
2608602745	100	2	25	28.72
2608601322	355	2.8	25	154.52
2608602751	355	3	20	155.40

CUTTING DISCS Standard for Metal				
Part Number	Diameter mm	Thickness mm	Pack Quantity	List Price ₹
2608619377	355	2.8	20	150.03
2608619382	355	3	20	150.30

NEW ECO 125 MM CUTTING DISC RANGE Standard for Metal				
Part Number	Description	Pack Quantity	List Price ₹	
2608603165	125 x 1.6 x 22.23 mm	25	34.39	
2608603166	125 x 2.5 x 22.23 mm	25	38.20	

NEW ECO 125 MM CUTTING DISC RANGE Standard for INOX				
Part Number	Description	Pack Quantity	List Price ₹	
2608603171	125 x 1 x 22.23 mm	25	32.47	
2608603172	125 x 1.6 x 22.23 mm	25	33.71	

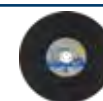
EXPERT FOR HEAVY METAL IN CUTTING AND GRINDING				
Part Number	Diameter mm	Thickness mm	Pack Quantity	List Price ₹
2608619394	355	3	25	162.54

CUTTING DISCS Standard for Inox				
Part Number	Diameter mm	Thickness mm	Pack Quantity	List Price ₹
2608603413	105	1	25	37.45

CUTTING DISCS Expert for Inox				
Part Number	Diameter mm	Thickness mm	Pack Quantity	List Price ₹
2608603462	125	1	50	68.27
2608607414	105	1	25	64.99
2608600549	125	1	25	130.79
2608600094	125	2	25	134.95
2608603498	180	1.6	25	152.81
2608600095	180	2	25	155.08
2608600322	180	3	25	117.64
2608600096	230	3	25	223.69

CUTTING DISCS Standard for Metal				
Part Number	Diameter mm	Thickness mm	Pack Quantity	List Price ₹
2608600663	100	1.2	25	50.11
2608600664	100	2.5	25	49.24
2608600665	125	3	25	63.54
2608600666	180	3	25	83.32
2608600667	230	3	25	141.55
2608600394	125	2.5	25	65.62
2608600321	180	3	25	83.11
2608600936	355	3	25	240.68

GRINDING DISCS Best for Metal				
Part Number	Diameter mm	Thickness mm	Pack Quantity	List Price ₹
2608601323	100	6	25	49.49
2608601324	125	6	25	81.32
2608601325	180	6.7	25	105.61
2608601326	230	6	25	175.14
2608603299	100	6	25	46.88
2608603300	125	6	25	82.64
2608603301	180	6.7	25	103.48
2608603302	230	6	10	183.72

NEW!**4 INCH GRINDING DISC**
Expert for Metal Grinding

Part Number	Diameter mm	Thickness mm	Pack Quantity	List Price ₹
2608619379	100	4.5	25	32.15
2608603686	100	6	25	33.62

GRINDING DISCS
Standard for Metal

Part Number	Diameter mm	Thickness mm	Pack Quantity	List Price ₹
2608602748	100	4	20	27.34
2608603227	125	6.8	20	70.44
2608603224	100	4	25	31.46

GRINDING DISCS
Expert for Inox

Part Number	Diameter mm	Thickness mm	Pack Quantity	List Price ₹
2608620690	100	2	10	60.22

GRINDING DISCS
Expert for Metal

Part Number	Diameter mm	Thickness mm	Pack Quantity	List Price ₹
2608602379	180	6.6	25	90.28

EXPERT FOR V - GRINDING DISCS

Part Number	Diameter mm	Thickness mm	Pack Quantity	List Price ₹
2608602374	180	5	25	86.26
2608602375	180	7	25	89.88

GRINDING DISCS - METAL

Part Number	Diameter mm	Thickness mm	Pack Quantity	List Price ₹
2608602372	100	6	25	41.36
2608602373	180	6.6	25	88.44

GRINDING DISCS - INOX

Part Number	Diameter mm	Thickness mm	Pack Quantity	List Price ₹
2608600539	115	6	25	131.87
2608600540	180	6	25	229.89
2608600541	230	6	25	308.69

BENCH GRINDING WHEEL

Part Number	Description	Bore mm	Pack Quantity	List Price ₹
1609201649	150 mm 24 Grit Coarse	20	1	421.29
1609201650	150 mm 60 Grit Fine	20	1	421.29
2608600111	200 mm 36 Grit Medium	32	1	667.13
2608600112	200 mm 60 Grit Fine	32	1	667.13

GRINDING STONE, CYLINDRICAL, MEDIUM-HARD

Part Number	Image	Dia. mm	Grit	Dia. mm	Length mm	Pack Qty	List Price ₹
1608620055		6	60	25	20	1	156.36
1608620056		6	60	20	25	1	156.69
2608620012		6	60	20	26	1	98.59
2608620014		6	60	20	25	1	179.01
1609200286		6	60	25	30	5	589.81

7 INCH CAST IRON GRINDING WHEEL**NEW!**

Part Number	Diameter mm	Thickness mm	Pack Quantity	List Price ₹
2608619702	180	6.6	25	103.00

WIRE CUP BRUSH CRIMPED WIRE

Part Number	Diameter mm	Wire Thickness mm	Pack Quantity	List Price ₹
1608614011	100	0.5	1	1,065.29

WIRE CUP BRUSH Crimped Wire, Brass-coated with Thread

Part Number	Diameter mm	Wire Thickness mm	Pack Quantity	List Price ₹
2608622062	75	0.3	1	668.04

WIRE CUP BRUSH Crimped Wire, Brass-coated

Part Number	Diameter mm	Wire Thickness mm	Pack Quantity	List Price ₹
1608614020	70	0.3	1	357.86

WIRE CUP BRUSH Knotted Wire M10

Part Number	Diameter mm	Wire Thickness mm	Pack Quantity	List Price ₹
2608622063	75	0.5	1	1211.87

WIRE CUP BRUSH Knotted Wire				
Part Number	Diameter mm	Wire Thickness mm	Pack Quantity	List Price ₹
1608622029	75	0.5	1	742.93
1608614002	100	0.8	1	1560.27

BRUSHING Pencil Brush				
Part Number	Diameter mm	Wire Thickness mm	Pack Quantity	List Price ₹
1609200269	25	0.3	1	308.18

BRUSHING Wire Wheel				
Part Number	Diameter mm	Wire Thickness mm	Pack Quantity	List Price ₹
2608622007	75	0.3	1	241.65

GRINDING DISCS Wire Wheel, Brass-coated				
Part Number	Diameter mm	Wire Thickness mm	Pack Quantity	List Price ₹
2608622009	75	0.2	1	369.17

WIRE CUP BRUSH Crimped Wire, Inox				
Part Number	Diameter mm	Wire Thickness mm	Pack Quantity	List Price ₹
2608622061	65	0.3	1	439.01

WIRE CUP BRUSH For Angle Grinders Knotted Wire, Stainless				
Part Number	Diameter mm	Wire Thickness mm	Pack Quantity	List Price ₹
2608622060	75	0.5	1	1683.80

TAPERED BRUSHES For Angle Grinders Crimped Wire				
Part Number	Diameter mm	Wire Thickness mm	Pack Quantity	List Price ₹
2608622057	100	0.3	1	1,013.86

TAPERED BRUSHES For Angle Grinders Knotted Wire				
Part Number	Diameter mm	Wire Thickness mm	Pack Quantity	List Price ₹
2608622011	100	0.5	1	1,103.11

WIRE BRUSHES				
Part Number	Bore Size	Tool to be Used	Pack Quantity	List Price ₹
2608622062	M10	4 inch grinder	1	668.04
2608622063	M10	4 inch grinder	1	1211.87
1608614002	M14	5/7 inch grinder	1	1560.27
1608614011	M14	5/7 inch grinder	1	1065.29
1608614020	M14	5/7 inch grinder	1	357.86
1608622029	M14	5/7 inch grinder	1	742.93
2608622011	M14	5/7 inch grinder	1	1103.11
2608622057	M14	5/7 inch grinder	1	1013.86
2608622060	M14	5/7 inch grinder	1	1683.80
2608622061	M14	5/7 inch grinder	1	439.01
1609200269	6mm shank	Rotary drill	1	308.18
2608622007	6mm shank	Rotary drill	1	241.65
2608622009	6mm shank	Rotary drill	1	369.17



SCREWDRIVING BITS



DOUBLE ENDED BITS



Part Number	Length mm	Dimensions	Pack Quantity	List Price ₹ /Pack
2608521038	PH2	45	10	400.45
2608521039	PH2*	65	10	408.72
2608521040	PH2	110	10	666.69
2608521041	PH2	45	10	357.07
2608521042	PH2*	65	10	349.72
2608521043	PH2	110	10	873.18

STANDARD FOR UNIVERSAL
Double Ended Screwdriver Bits
PH2 / SL6

Part Number	Length mm	Pack Quantity	List Price ₹ /Pack
2608522265*	65	10	362.89
2608522266	110	10	487.75

SOCKETS FOR IMPACT
WRENCHES

Part Number	Length of Socket mm	A/F Size	Square Drive inches	Pack Quantity	List Price ₹
1608552000	30.0	7.0	3/8"	1	166.13
1608552001	30.0	8.0	3/8"	1	166.13
1608552003	30.0	10.0	3/8"	1	167.54
1608552005	30.0	12.0	3/8"	1	170.39
1608552006	30.0	13.0	3/8"	1	170.39
1608552008	30.0	15.0	3/8"	1	173.24
1608552009	30.0	16.0	3/8"	1	174.64
1608552010	30.0	17.0	3/8"	1	188.85
2608522301	30.0	19.0	3/8"	1	201.62
1608552012	38.0	10.0	1/2"	1	201.62
1608552013	38.0	11.0	1/2"	1	203.05
1608552015	38.0	13.0	1/2"	1	204.46
1608552019	38.0	17.0	1/2"	1	211.56
1608552021	38.0	19.0	1/2"	1	222.92
2608522307	38.0	21.0	1/2"	1	259.85
1608555024	38.0	22.0	1/2"	1	266.95
1608555053	38.0	24.0	1/2"	1	281.14
1608555059	38.0	27.0	1/2"	1	345.05
1608555065	38.0	30.0	1/2"	1	425.98
2608522302	77.0	10.0	1/2"	1	306.70
2608522303	77.0	11.0	1/2"	1	308.13
2608522304	77.0	13.0	1/2"	1	309.55
2608522305	77.0	17.0	1/2"	1	312.39
2608522306	77.0	19.0	1/2"	1	336.51
2608522308	77.0	21.0	1/2"	1	354.98

SOCKETS FOR IMPACT
WRENCHES







Part Number	Length of Socket mm	A/F Size	Square Drive inches	Pack Quantity	List Price ₹
2608522309	77.0	22.0	1/2"	1	404.68
2608522310	77.0	24.0	1/2"	1	435.92
2608522311	77.0	27.0	1/2"	1	516.85
1608556005	50.0	19.0	3/4"	1	553.77
1608556011	50.0	22.0	3/4"	1	563.70
1608556015	51.0	24.0	3/4"	1	565.13
1608556021	52.0	27.0	3/4"	1	624.78
1608556027	54.0	30.0	3/4"	1	663.10
1608556029	56.0	32.0	3/4"	1	702.87

SOCKETS FOR IMPACT
WRENCHES

Part Number	Length of Socket	A/F Size	Square Drive inches	Pack Quantity	List Price ₹
1608551002	40	6	1/4"	1	120.00
1608551003	25	7	1/4"	1	120.00
1608551004	25	8	1/4"	1	119.00
1608551005	25	9	1/4"	1	120.00
1608551006	25	10	1/4"	1	122.00
1608551007	25	11	1/4"	1	126.00
1608551008	25	12	1/4"	1	128.00
1608551009	25	13	1/2"	1	131.00
2608622300	25	14	1/4"	1	139.00

IMPACT DOUBLE ENDED
SCREWDRIVING BITS

NEW!



Part Number	Description	Pack Quantity	List Price ₹
2608522405	Expert for Impact 6.35 x 65 mm, black oxide, PH2 double-ended 	10	766.94
2608522406	Expert for Impact 6.35 x 110 mm, black oxide, PH2 double-ended 	10	1242.86
2608522407	Expert for Impact 6.35 x 150 mm, black oxide, PH2 double-ended 	5	1036.94
2608522408	Expert for impact 6.35 x 65 mm black oxide PH2 Bits 	2	171.25
2608522409	Expert for impact 6.35 x 110 mm black oxide PH2 Bits 	2	278.41
2608522410	Expert for impact 6.35 x 150 mm black oxide PH2 Bits 	2	424.44



BOSCH
GBM 13
Professional



**METAL
DRILL BITS**

HSS Drill Bits – range overview

	HSS PointTeQ	HSS Ground	HSS Cobalt
			
Lifetime	● ●	● ●	● ● ●
Speed	● ● ●	● ● ●	● ● ●
Precision	● ●	● ● ●	● ● ●
Features	Fast Drilling in Metal	Highest-Precision Holes	Long Lifetime when Drilling Stainless Steel

	Plastic	Non Alloy Steel	Non-Ferrous Metals	Cast Steel	Aluminium and Alloy Steel	Cast Iron	Stainless Steel
HSS PointTeQ 	●	●	●	●	○	○	-
HSS Ground 	●	●	●	●	●	○	-
HSS Cobalt 	○	○	●	●	●	●	●

● Recommended ○ Acceptable - Not Recommended



HSS PointTeQ

Fast Drilling in Metal

Increased lifetime

As a result of its fast drilling rate which leads to reduced wear

Fast chip removal

Supported by the black-oxide coated flute

Low risk of breakage

Due to drill bit body manufactured with high elasticity



Fast and easy start

The self-centering PointTeQ tip design allows an easy and efficient start



- ▶ HSS PointTeQ enables fast drilling in metal due to PointTeQ tip design
- ▶ Self-centering tip prevents wandering, making quick and easy drilling starts possible
- ▶ Increased drilling rate generates less heat and wear
- ▶ PointTeQ tip design remains sharp and ensures continuous durability
- ▶ Manufactured to DIN 338

NEW!

**METAL DRILL BITS HSS PointTeQ
DIN 338**

Part Number	Diameter (D) mm	Working Length (L1) mm	Diameter (D) Inch	Pack Quantity	List Price ₹ / Pack
2608577178	1	12	-	10	109.71
2608577179	1.1	14	-	10	91.40
2608577180	1.2	80	-	10	91.40
2608577181	1.3	16	-	10	91.40
2608577182	1.4	18	-	10	91.40
2608577183	1.5	18	-	10	109.71
2608577184	1.6	20	-	10	98.76
2608577185	1.7	20	-	10	98.76
2608577186	1.8	22	-	10	118.83
2608577187	1.9	22	-	10	98.76
2608577188	2	24	-	10	118.83
2608577189	2.1	24	-	10	106.11
2608577190	2.2	27	-	10	106.11
2608577191	2.3	27	-	10	106.11
2608577192	2.4	30	-	10	106.11
2608577193	2.5	30	-	10	127.14
2608577194	2.6	30	-	10	107.10
2608577195	2.7	33	-	10	107.10
2608577196	2.8	33	-	10	132.14
2608577197	2.9	33	-	10	110.31
2608577198	3	33	-	10	132.14
2608577199	3.1	36	-	10	132.38
2608577200	3.2	36	-	10	160.38
2608577201	3.3	36	-	10	160.38
2608577202	3.4	39	-	10	132.38
2608577203	3.5	39	-	10	160.38
2608577204	3.6	39	-	10	186.15
2608577205	3.7	39	-	10	186.15
2608577206	3.8	43	-	10	186.15
2608577207	3.9	43	-	10	155.49
2608577208	4	43	-	10	220.22
2608577209	4.1	43	-	10	253.47
2608577210	4.2	43	-	10	253.47
2608577211	4.3	47	-	10	212.22
2608577212	4.4	47	-	10	212.22
2608577213	4.5	47	-	10	253.47
2608577214	4.6	47	-	10	255.30
2608577215	4.7	47	-	10	255.30

NEW!

**METAL DRILL BITS HSS PointTeQ
DIN 338**

Part Number	Diameter (D) mm	Working Length (L1) mm	Diameter (D) Inch	Pack Quantity	List Price ₹ / Pack
2608577216	4.8	52	-	10	304.16
2608577217	4.9	52	-	10	304.16
2608577218	5	52	-	10	304.16
2608577219	5.1	52	-	10	406.38
2608577220	5.2	52	-	10	339.34
2608577221	5.3	52	-	10	339.34
2608577222	5.4	57	-	10	339.34
2608577223	5.5	57	-	10	406.38
2608577224	5.6	57	-	10	367.71
2608577225	5.7	57	-	10	367.71
2608577226	5.8	57	-	10	367.71
2608577227	5.9	57	-	10	367.71
2608577228	6	57	-	10	439.61
2608577229	6.1	63	-	10	396.08
2608577230	6.2	63	-	10	473.70
2608577231	6.3	63	-	10	396.08
2608577232	6.4	63	-	10	396.08
2608577233	6.5	63	-	10	473.70
2608577234	6.6	63	-	10	466.47
2608577235	6.7	63	-	10	466.47
2608577236	6.8	69	-	10	558.46
2608577237	6.9	69	-	10	466.47
2608577238	7	69	-	10	558.46
2608577239	7.1	69	-	10	523.20
2608577240	7.2	69	-	10	523.20
2608577241	7.3	69	-	10	625.77
2608577242	7.4	69	-	10	523.20
2608577243	7.5	69	-	10	625.77
2608577244	7.6	75	-	10	612.50
2608577245	7.7	75	-	10	612.50
2608577246	7.8	75	-	10	612.50
2608577247	7.9	75	-	10	612.50
2608577248	8	75	-	10	678.69
2608577249	8.1	75	-	10	707.05
2608577250	8.2	75	-	10	707.05
2608577251	8.3	75	-	10	707.05
2608577252	8.4	75	-	10	707.05

NEW!

**METAL DRILL BITS HSS PointTeQ
DIN 338**

Part Number	Diameter (D) mm	Working Length (L1) mm	Diameter (D) Inch	Pack Quantity	List Price ₹
2608577253	8.5	75	-	10	750.13
2608577254	8.6	81	-	10	778.49
2608577255	8.7	81	-	10	778.49
2608577256	8.8	81	-	10	778.49
2608577257	8.9	81	-	10	778.49
2608577258	9	81	-	10	848.88
2608577259	9.1	81	-	10	864.64
2608577260	9.2	81	-	10	864.64
2608577261	9.3	81	-	10	864.64
2608577262	9.4	81	-	10	864.64
2608577263	9.5	81	-	10	1082.84
2608577264	9.6	87	-	10	947.64
2608577265	9.7	87	-	10	947.64
2608577266	9.8	87	-	10	947.64
2608577267	9.9	87	-	10	947.64
2608577268	10	87	-	10	990.72
2608577316	-	23	1/16	10	119.77
2608577317	-	26	5/64	10	127.12
2608577318	-	33	3/32	10	140.78
2608577319	-	39	7/64	10	148.13
2608577320	-	42	1/8	10	169.15
2608577321	-	45	9/64	10	182.80
2608577322	-	52	5/32	10	224.83
2608577323	-	55	11/64	10	253.19
2608577324	-	61	3/16	10	309.93
2608577325	-	64	13/64	10	393.98
2608577326	-	66	7/32	10	422.34
2608577327	-	69	15/64	10	450.71
2608577328	-	72	1/4	10	492.73
2608577329	-	75	17/64	10	563.12
2608577330	-	77	9/32	10	633.51
2608577331	-	80	19/64	10	633.51
2608577332	-	83	5/16	10	774.29
2608577333	-	87	21/64	10	844.68
2608577334	-	90	11/32	10	915.07
2608577335	-	92	23/64	10	1,055.85
2608577336	-	95	3/8	10	1,055.85
2608577337	-	98	25/64	10	1,126.24

NEW!

**METAL DRILL BITS HSS PointTeQ
DIN 338**

Part Number	Diameter (D) mm	Working Length (L1) mm	Diameter (D) Inch	Pack Quantity	List Price ₹
2608577269	10.1	87	-	5	566.27
2608577270	10.2	87	-	5	566.27
2608577271	10.3	87	-	5	566.27
2608577272	10.4	87	-	5	566.27
2608577273	10.5	87	-	5	566.27
2608577274	10.6	87	-	5	636.66
2608577275	10.7	94	-	5	636.66
2608577276	10.8	94	-	5	636.66
2608577277	10.9	94	-	5	636.66
2608577278	11	94	-	5	636.66
2608577279	11.1	94	-	5	678.69
2608577280	11.2	94	-	5	678.69
2608577281	11.3	94	-	5	678.69
2608577282	11.4	94	-	5	678.69
2608577283	11.5	94	-	5	678.69
2608577284	11.6	94	-	5	735.42
2608577285	11.7	94	-	5	735.42
2608577286	11.8	94	-	5	735.42
2608577287	11.9	101	-	5	735.42
2608577288	12	101	-	5	735.42
2608577289	12.1	101	-	5	778.49
2608577290	12.2	101	-	5	778.49
2608577291	12.3	101	-	5	778.49
2608577292	12.4	101	-	5	778.49
2608577293	12.5	101	-	5	778.49
2608577294	12.6	101	-	5	848.88
2608577295	12.7	101	-	5	848.88
2608577296	12.8	101	-	5	848.88
2608577297	12.9	101	-	5	848.88
2608577298	13	101	-	5	1,014.70
2608577338	-	101	13/32	5	633.51
2608577339	-	101	27/64	5	703.90
2608577340	-	101	7/16	5	774.29
2608577341	-	101	29/64	5	774.29
2608577342	-	101	15/32	5	816.32
2608577343	-	101	31/64	5	915.07
2608577344	-	101	1/2	5	985.46

HSS Ground

Highest-Precision Holes



Excellent cutting features

135° tip design enables up to 40 % faster drilling rate and up to 50 % lower feed pressure than standard HSS drills with chisel edge.

Tight tolerances and accurate holes

as a result of its precision-ground drill bit body.

Quick start and perfect centering

Self-centering split point drills precisely where it is positioned. No need to pre-punch up to 10 mm diameter.



- ▶ HSS Ground is for drilling through metal with highest precision
- ▶ Active cutting and perfect centering without wandering is achieved by split point tip
- ▶ Precision-ground bit made of HSS enables fast results
- ▶ No need to pre-punch or pilot drill up to 10 mm-diameter
- ▶ Manufactured to DIN 338, diameter tolerance h8

METAL DRILL BITS HSS-G



Part Number	Diameter Inches	Pack Quantity	List Price ₹ / Pack
2608585433	1/64	10	195.30
2608585434	1/32	10	195.30
2608585435	3/64	10	195.30
2608585436	1/16	10	195.30
2608585437	5/64	10	195.30
2608585438	3/32	10	195.30
2608585439	7/64	10	201.08
2608585440	1/8	10	211.50
2608585441	9/64	10	239.70
2608585442	5/32	10	269.00
2608585443	11/64	10	327.70
2608585444	3/16	10	428.07
2608585445	13/64	10	493.09
2608585446	7/32	10	516.93
2608585447	15/64	10	581.97
2608585448	1/4	10	623.12
2608585449	17/64	10	816.77
2608585450	9/32	10	859.33
2608585451	19/64	10	996.93
2608585452	5/16	10	1082.48
2608585453	21/64	5	738.91
2608585454	11/32	5	697.52
2608585455	23/64	5	873.11
2608585456	3/8	5	930.03
2608585457	25/64	5	951.88
2608585458	13/32	5	980.01
2608585459	27/64	5	1045.22
2608585460	7/16	5	1189.49
2608585461	29/64	5	1206.73
2608585462	15/32	5	1328.87
2608585463	31/64	5	1416.39
2608585464	1/2	5	1802.80

METAL DRILL BITS HSS-G



Part Number	Diameter Inches	Pack Quantity	List Price ₹ / Pack
2608595049	1	10	140.55
2608585467	1.1	10	145.07
2608585468	1.2	10	145.38
2608585469	1.3	10	139.52
2608585470	1.4	10	139.29
2608595050	1.5	10	146.14
2608585471	1.6	10	155.07
2608585472	1.7	10	156.24
2608585473	1.8	10	158.68
2608585474	1.9	10	148.92
2608595051	2	10	156.96
2608585475	2.1	10	152.08
2608595052	2.2	10	152.50
2608585476	2.3	10	157.59
2608585477	2.4	10	160.43
2608595053	2.5	10	170.67
2608585478	2.6	10	165.75
2608585479	2.7	10	167.12
2608595054	2.8	10	173.77
2608585480	2.9	10	170.83
2608595055	3	10	187.57
2608585481	3.1	10	211.14
2608595056	3.2	10	214.94
2608595057	3.3	10	218.76
2608585482	3.4	10	223.20
2608595058	3.5	10	230.65
2608595332	3.6	10	221.88
2608585483	3.7	10	263.68
2608585484	3.8	10	277.11
2608585485	3.9	10	280.92
2608595059	4	10	290.02
2608585486	4.1	10	326.07
2608595060	4.2	10	335.45
2608585487	4.3	10	346.61
2608595333	4.4	10	357.78
2608595061	4.5	10	368.90

METAL DRILL BITS HSS-G



Part Number	Diameter mm	Pack Quantity	List Price ₹
2608585488	4.6	10	375.22
2608585489	4.7	10	380.26
2608595334	4.8	10	453.52
2608585490	4.9	10	465.08
2608595062	5	10	468.25
2608585491	5.1	10	499.30
2608595063	5.2	10	505.79
2608585492	5.3	10	499.22
2608585493	5.4	10	518.94
2608595064	5.5	10	524.51
2608585494	5.6	10	539.64
2608585495	5.7	10	547.73
2608595065	5.8	10	559.10
2608585496	5.9	10	565.80
2608595066	6	10	571.26
2608585497	6.1	10	552.88
2608595067	6.2	10	606.51
2608585498	6.3	10	624.87
2608595335	6.4	10	621.48
2608595068	6.5	10	709.25
2608585499	6.6	10	776.07
2608595336	6.7	10	771.14
2608595069	6.8	10	837.00
2608585500	6.9	10	837.00
2608595070	7	10	880.15
2608585501	7.1	10	861.04
2608595337	7.2	10	2059.02
2608585502	7.3	10	896.45
2608585503	7.4	10	912.00
2608595071	7.5	10	907.22
2608585504	7.6	10	1038.82
2608585505	7.7	10	2311.62
2608585506	7.8	10	2311.62
2608585507	7.9	10	1592.58
2608595072	8	5	548.70
2608585508	8.1	5	601.80

METAL DRILL BITS HSS-G



Part Number	Diameter mm	Pack Quantity	List Price ₹
2608585509	8.2	5	614.81
2608585510	8.3	5	670.91
2608585511	8.4	5	1457.49
2608595073	8.5	5	653.65
2608585512	8.6	5	668.48
2608585513	8.7	5	690.57
2608595074	8.8	5	704.78
2608585514	8.9	5	710.39
2608595075	9	5	696.69
2608585515	9.1	5	1901.66
2608585516	9.2	5	904.72
2608585517	9.3	5	851.97
2608585518	9.4	5	1849.29
2608595076	9.5	5	937.34
2608585519	9.6	5	926.35
2608585520	9.7	5	2063.50
2608595338	9.8	5	884.22
2608585521	9.9	5	2060.13
2608595077	10	5	927.39
2608585522	10.1	5	932.15
2608585523	10.2	5	902.97
2608585524	10.3	5	1020.95
2608585525	10.4	5	1053.66
2608595078	10.5	5	1008.80
2608585526	10.6	5	2218.60
2608585527	10.7	5	1048.92
2608585528	10.8	5	2377.07
2608585529	10.9	5	2311.62
2608595079	11	5	1063.70
2608585530	11.1	5	1,150.17
2608585531	11.2	5	1,152.64
2608585532	11.3	5	2542.78
2608585533	11.4	5	2542.78
2608595080	11.5	5	1212.27
2608585534	11.6	5	1302.32
2608585535	11.7	5	1307.75

METAL DRILL BITS HSS-G



Part Number	Diameter mm	Pack Quantity	List Price ₹
2608585536	11.8	5	1313.17
2608585537	11.9	5	1355.94
2608595081	12	5	1354.91
2608585538	12.1	5	1375.27
2608585539	12.2	5	1391.69
2608585540	12.3	5	1354.41
2608585541	12.4	5	1394.99
2608595082	12.5	5	1399.15
2608585542	12.6	5	1434.07
2608585543	12.7	5	1777.04
2608585544	12.8	5	1779.84
2608585545	12.9	5	1835.83
2608595083	13	5	1850.28
2608585593	14	4	3130.38
2608585595	16	4	4310.38

METAL DRILL BIT SET



Part Number	Diameter mm	Pack Quantity	List Price ₹
2607017152	1 - 10	19	819.25

10-PIECE METAL DRILL BIT SET HSS-G



Part Number	Diameter mm	Pack Quantity	List Price ₹
2607019115	1.0, 2.0, 3.0, 4.0, 5.0, 6.0, 7.0, 8.0, 9.0, 10.0	1	1056.35

10-HSS-R METAL DRILL BITS SET



Part Number	Diameter mm	Pack Quantity	List Price ₹
2609255030	1.2 / 2.0 / 3.0 / 4.0 / 5.0 / 6.0 / 7.0 / 8.0 / 9.0 / 10.0	1	439.46

13-PIECE METAL DRILL BIT SET HSS-TIN



Part Number	Diameter mm	Pack Quantity	List Price ₹
2607019436	1.5, 2.0, 2.5, 3.0, 3.2, 3.5, 4.0, 4.5, 4.8, 5.0, 5.5, 6.0, 6.5"	13	442.27

25-PIECE METAL DRILL BIT SET HSS-TIN



Part Number	Diameter mm	Pack Quantity	List Price ₹
2607018727	1; 1.5; 2; 2.5; 3; 3.5; 4; 4.5; 5; 5.5; 6; 6.5; 7; 7.5; 8; 8.5; 9; 9.5; 10; 10.5; 11; 11.5; 12; 12.5; 13	25	2373.00



WOOD DRILL BITS



WOOD SPADE BITS CLEAN CUT RANGE



Part Number	Diameter mm	Total Length mm	Pack Quantity	List Price ₹
2608587496	6	155	1	77.59
2608587497	8	155	1	78.62
2608587498	10	155	1	87.92
2608587499	12	155	1	88.95
2608587500	13	155	1	93.10
2608587501	14	155	1	94.14
2608587502	16	160	1	100.34
2608587504	18	160	1	101.38
2608587505	19	160	1	110.69

WOOD SPADE BITS CLEAN CUT RANGE



Part Number	Diameter mm	Total Length mm	Pack Quantity	List Price ₹
2608587506	20	160	1	116.91
2608587507	22	160	1	127.24
2608587508	24	160	1	134.48
2608587509	25	160	1	140.70
2608587511	28	165	1	157.23
2608587512	30	165	1	165.51
2608587513	32	165	1	177.94
2608587514	35	165	1	225.52
2608587516	38	165	1	227.58





DRILLING

SDS Plus Hammer



SDS-PLUS SHANK



	SDS-PLUS-1	SDS-PLUS-3	SDS-PLUS-5	SDS-PLUS-5X
				
Lifetime	•	••	•••	••••
Speed	••	••	••••	•••
Drilling dust removal	•••	•••	••••	••••
Tip		Centring tip	Centring tip Wear mark Carbide relief grooves	Centring tip Special cutting geometry for efficient dust removal and robust tip
Cutting edges	2-cutter	2-cutter	2-cutter AWB brazing and hardening	Carbide 4-cutter
Carbide	Standard carbide	Fine grade, highly durable carbide	Fine grade, highly durable carbide	Fine grade, highly durable carbide
Flute	2-flute U-shape	4-flute dura design	4-flute turbo design	4-flute robust design



Low-cost drilling



Long lifetime



User-friendly drilling



Efficient drilling and resistant to rebar

•/•• = good

•••/••••• = better

••••• = best

SDS PLUS-1

Quality Hit, Budget Fit

8% more affordable

NEW!



x 11 =



NEW!

SDS PLUS-1 Pack Quantity 11			
Part Number	Description	Pack Quantity	List Price ₹ /Pack
2608579911	6 x 50 x 110	11	693.40
2608579912	8 x 50 x 110	11	772.19
2608579708	6 x 100 x 160	11	740.67
2608579709	8 x 100 x 160	11	826.82
2608579710	10 x 100 x 160	11	883.55
2608579711	12 x 100 x 160	11	907.72

NEW!

SDS PLUS-1 - DRILL BIT SETS			
Part Number	Description	Pack Quantity	List Price ₹ /Pack
2608579118	6x100x160, 8x100x160, 10x100x160	3	226.93
2608579119	5x50x110, 6x50x110, 6x100x160, 8x100x160, 10x100x160	5	357.20
2608579120	6x100x160, 6x100x160, 8x100x160, 10x100x160, 12x100x160	5	378.22
2608579121	5x50x110, 6.5x50x110, 8x50x110, 10x100x160, 12x100x160	5	386.62

**SDS PLUS-1 HAMMER
DRILL BIT***

Part Number	Diameter mm	Working Length mm	Pack Quantity	List Price ₹
2608680257	4	50	1	83.33
2608680258	5	50	1	69.96
2608680259	5	100	1	93.11
2608680260	5.5	50	1	94.60
2608680261	5.5	100	1	92.77
2608680262	6	50	1	68.34
2608680263	6	100	1	74.15
2608680264	6	150	1	113.73
2608680265	6.5	50	1	87.15
2608680266	6.5	100	1	94.54
2608680267	7	50	1	93.14
2608680268	7	100	1	97.49
2608680269	8	50	1	76.27
2608680270	8	100	1	82.68
2608680271	8	150	1	124.01
2608680272	8	200	1	157.57
2608680273	10	100	1	88.33
2608680274	10	150	1	113.32
2608680275	10	200	1	155.85
2608680276	10	400	1	250.37

**SDS PLUS-1 HAMMER
DRILL BIT***

Part Number	Diameter mm	Working Length mm	Pack Quantity	List Price ₹
2608680277	12	100	1	90.70
2608680278	12	150	1	128.88
2608680279	12	200	1	175.17
2608680280	12	400	1	306.90
2608680281	14	100	1	148.72
2608680282	14	150	1	210.04
2608680283	14	200	1	236.78
2608680284	14	400	1	332.10
2608680285	16	150	1	216.64
2608680286	16	250	1	260.52
2608680287	16	400	1	450.10
2608680288	18	200	1	289.37
2608680289	18	400	1	483.91
2608680290	20	200	1	464.35
2608680291	20	400	1	628.42
2608680292	22	200	1	506.02
2608680293	22	400	1	752.09
2608680294	25	200	1	568.49
2608680295	25	400	1	812.00

DRILLING

Masonry Drill Bit



MASONRY DRILL BIT - CYL-1

Pack Quantity 10 pc



Part Number	Diameter mm	Working Length mm	Total Length mm	Pack Quantity	List Price ₹ /Pack
2608590200	3	30	60	10	153.77
2608590202	4	40	75	10	198.09
2608590205	5	50	85	10	223.85
2608590208	6	60	100	10	259.03
2608590210	6.5	60	100	10	288.76
2608590212	8	80	120	5	184.84
2608590214	10	80	120	5	251.10

MASONRY DRILL BIT - CYL-2

Pack Quantity 10 pc



Part Number	Diameter mm	Working Length mm	Pack Quantity	List Price ₹ /Pack
2608579311	3	30	10	238.49
2608579312	5	50	10	306.78
2608579314	6	60	10	351.95

**MASONRY DRILL BIT SETS
CYL-1 - For Masonry Brick
applications only****NEW!**

Part Number	Diameter mm	Pack Quantity	List Price ₹
2608590090	4mm, 5mm, 6mm, 8mm, 10mm	5	177.64

**MASONRY DRILL BIT -
CYL-2**

Part Number	Diameter mm	Working Length mm	Pack Quantity	List Price ₹
2608578114	3	30	1	26.54
2608578115	4	40	1	29.46
2608578116	5	50	1	34.13
2608578117	5.5	50	1	36.90
2608578118	6	60	1	39.19
2608578119	6.5	60	1	40.47
2608578120	8	80	1	57.53
2608578159	9	80	1	68.75
2608578121	10	80	1	79.66
2608578122	12	90	1	106.20
2608578123	14	90	1	140.35
2608578160	16	90	1	168.17
2608578124	6,8,10	-	set	165.01
2608578155	4,5,6,8,10	-	set	218.11
2608578156	3,4,5,6, 7,8,9,10	-	set	353.28

**MASONRY / IMPACT DRILL BIT
CYL-2 SETS - For Masonry Brick +
Light Concrete applications****NEW!**

Part Number	Diameter mm	Pack Quantity	List Price ₹
2608578124	6mm, 8mm, 10mm	3	165.01
2608578155	4mm, 5mm, 6mm, 8mm, 10mm	5	218.11
2608578156	3mm, 4mm, 5mm, 6mm, 7mm, 8mm, 9mm, 10mm	8	353.28

**SDS MAX-9 BREAKTHROUGH
For drilling in Masonry, Tiles,
Thin Metal & Light Concrete**

Part Number	Diameter mm	Working Length mm	Pack Quantity	List Price ₹
2608680698	5	50	1	111.27
2608680792	6	60	1	115.65
2608680793	6.5	60	1	97.39
2608680795	8	80	1	129.67
2608680796	10	80	1	136.65



DIAMOND CUTTING, GRINDING & DRILLING



BEST IN CLASS PRICE / PERFORMANCE RATIO

Turbo Tile Cutting Blade

2608603611

Part Number	Diameter mm	Bore mm	Segment Height mm	Pack Qty	List Price ₹
2608603611	110	16/20	10	1	201.11

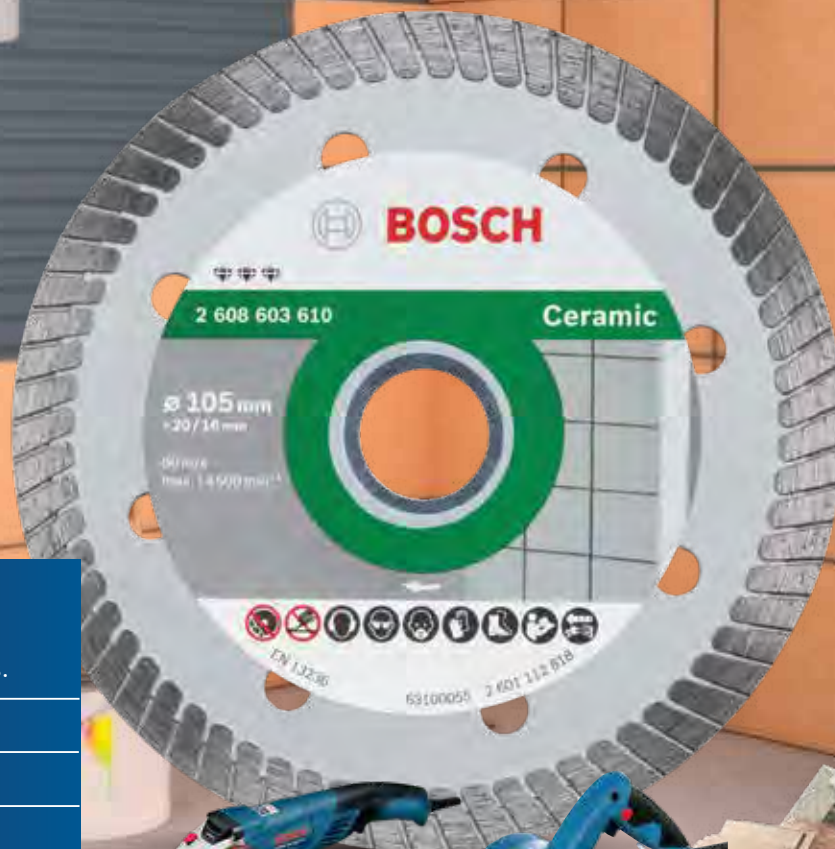

BENEFITS / WHY BOSCH?

- ▶ Can be used on both ceramic & glazed tiles.
- ▶ Zero chipping.
- ▶ Less material wastage.
- ▶ Good surface finish.

MATERIALS: Ceramic, Glazed tiles

DIAMOND CUTTING DISCS
 Expert for Universal with
 16 / 20 mm Bore

Part Number	Diameter mm	Segment Height mm	Pack Quantity	List Price ₹ /Piece
2608602797	105	7	10	90.97
2608602460	110	12	1	172.14
2608615049	110	10	1	125.70

4 INCH FULL RIM DIAMOND CUTTING DISCS
 For Tile Cutting

Part Number	Diameter mm	Bore mm	Segment Height mm	Pack Quantity	List Price ₹ /Piece
2608602798	105	16/20	7	10	113.18
2608615050	110	16/20	10	1	126.93

4 INCH DIAMOND CUTTING DISCS
 For Stone Cutting

Part Number	Diameter mm	Bore mm	Segment Height mm	Pack Quantity	List Price ₹
2608602464	110	16/20	12	1	173.43

DIAMOND CUTTING DISCS
 Expert for Universal 5" - 9"
 with 22.23 mm Bore

Part Number	Diameter mm	Segment Height mm	Pack Quantity	List Price ₹
2608615111	125	12	1	201.87
2608615112	150	12	1	228.10
2608615113	180	12	1	333.81
2608615114	230	12	1	528.55

DIAMOND CUP WHEEL
 Expert for Universal Turbo

Part Number	Diameter mm	Segment Height mm	Pack Quantity	List Price ₹
2608603606	100	2.5	1	606.25

NEW!
ECO RANGE 5 INCH CONCRETE GRINDING WHEELS

Part Number	Diameter mm	Segment Height mm	No. of Segments	Pack Quantity	List Price ₹
2608601778	100	2.5	-	1	667.44
2608601762	125	5	18	1	1291.19
2608601763	125	5	9	1	1223.95



HOLESAWING



**HSS BI-METAL HOLESAWS
FOR STANDARD ADAPTERS**

Part Number	Diameter mm	Pack Quantity	List Price ₹
2608580396	14	1	217.46
2608580397	16	1	181.57
2608580398	17	1	197.10
2608580399	19	1	190.07
2608580401	21	1	188.24
2608580402	22	1	209.30
2608580404	25	1	229.97
2608580405	27	1	236.63
2608580406	29	1	270.01
2608580407	30	1	317.33
2608580408	32	1	287.21
2608580410	35	1	312.64
2608580411	37	1	324.93
2608580412	38	1	331.29
2608580413	40	1	331.01
2608580414	41	1	341.80
2608580416	44	1	375.73
2608580418	48	1	422.08
2608580419	51	1	457.12
2608580420	52	1	457.87
2608580421	54	1	466.48
2608580423	57	1	498.72
2608580425	60	1	518.02
2608580426	64	1	527.61
2608580427	65	1	539.80
2608580428	67	1	579.17
2608580430	70	1	593.58
2608580431	73	1	654.70
2608580432	76	1	703.38
2608580433	79	1	738.43
2608580434	83	1	770.93
2608580435	86	1	803.63
2608580436	89	1	761.14
2608580437	92	1	954.91
2608580438	95	1	879.41
2608580439	98	1	848.99
2608580440	102	1	881.34
2608580444	114	1	1053.22
2608580445	121	1	1300.51
2608580446	127	1	1189.58
2608580448	152	1	1458.88

**ACCESSORIES FOR
STANDARD BI-METAL
HOLESAWS**

Part Number	Description	Pack Quantity	List Price ₹
2608596119	HSS-G pilot drill bit for hexagon socket adapter, width across flats 11 mm	1	234.48
2609390588	Hex adapter with 1/2"-20UNF thread and HSS-G pilot drill bit (2 608 596 295) Width across flats 9.52 mm, from diameter 14 mm / 9/16" to diameter 30 mm / 1 3/16"	1	350.95
2609390034	Hexagon adapter with 5/8"-18UNF thread and HSS-G pilot drill bit (2 608 596 119) Width across flats 11 mm, from 32 mm / 1 1/4" to diameter 210 mm / 8 9/32"	1	798.91
2609390036	SDS-plus adapter with 5/8" 18UNF thread and HSS-G pilot drill bit (2 608 596 295) From 32mm / 1 1/4" to 210mm / 8 9/32" Holesaw	1	1,336.27

HOLE CUTTERS

Part Number	Description	Pack Quantity	List Price ₹
2607019449	7 piece set	1	367.89
2607019450	11 piece set	1	705.33

HOLESAW SETS

Part Number	Description	Pack Quantity	List Price ₹
2608580803	- Plumber set, 9pc, 6HS, 2 hex socket adapter, 1 hex nutsetter - BiM - Standard HS Ecoline Set 19/22/29/38/44/57	1	2626.50
2608580804	- Electrician set, 9pc, 6HS, 2 hex socket adapter, 1 hex nutsetter - BiM - Standard HS Ecoline Set 20/25/32/38/51/64	1	2941.68
2608580862	- Universal set, 9pc, 6HS, 2 hex socket adapter, 1 hex nutsetter - BiM - Standard HS Ecoline Set 24/27/32/35/40/52	1	2626.50
2608580868	- Electrician set, 9pc, 6HS, 2 hex socket adapter, 1 hex nutsetter - BiM - Standard HS Ecoline Set 20/25/35/40/51/68	1	3256.86
2608580866	- Universal set, 12pc, 9HS, 1 hex socket adapter, 1 305mm extension, 1 hex nutsetter - BiM - Standard HS Ecoline Set 35/54/70/76/83/95/102/114/127	1	7879.50

JIGSAW BLADES



JIGSAW BLADES Basic for Wood



Part Number	Description	Pack Quantity	List Price ₹
2608630037	T 119 B - HCS, wavy set, milled softwood (2-15 mm), plywood, chipboards, wood core plywood, fibre boards	92	5 206.60
2608630310	T 119 BO - HCS, wavy set, milled softwood (2-15 mm), plywood, chipboard, wood core plywood, fibre boards, especially for curve cuts	83	5 354.48
2608637879	T 119 BO - HCS, wavy set, milled softwood (2-15 mm), plywood, chipboard, wood core plywood, fibre boards, especially for curve cuts	83	100 2964.18
2608630033	T 111 C - HCS, side set, milled softwood (4-50 mm), chipboard, wood core plywood, fibre boards, quick cut	100	5 218.62
2608637878	T 111 C - HCS, side set, milled softwood (4-50 mm), chipboard, wood core plywood, fibre boards, quick cut	100	100 4057.76

JIGSAW BLADES Speed for Wood



Part Number	Description	Total Length mm	Pack Qty	List Price ₹
2608637944	T 344 D Speed for Wood Jigsaw Blade makes fast straight cuts in wood	152	3	238.82
2608630040	T 144 D Speed for Wood Jigsaw Blade delivers fast straight cuts in wood	100	5	214.24
2608637880	T 144 D - HCS, side set, ground softwood (5-50 mm), chipboards, wood core plywood, fibre boards	100	100	3728.40
2608630058	T 244 D - HCS, side set, ground softwood (5-50 mm), chipboards, wood core plywood, fibre boards, especially for curve cuts	100	5	251.26
2608637881	T 244 D - HCS, side set, ground softwood (5-50 mm), chipboards, wood core plywood, fibre boards, especially for curve cuts	100	100	3980.02
2608663314	T 744 D - HCS, side set, ground softwood/ boards, thick construction timber, sandwich materials	180	3	1815.45

JIGSAW BLADES Clean for Wood



Part Number	Description	Total Length mm	Pack Qty	List Price ₹
2608630031	T 101 AO - HCS, pointed teeth, ground teeth and taper ground softwood, plywood, laminated panels (1.5-15 mm), especially for curve cuts	83	5	304.06
2608630030	T 101 B - HCS, ground teeth and taper ground softwood, chipboard, wood core plywood, fibre boards (3-30 mm), plastics/ epoxy (diameter <30 mm)	100	5	301.83
2608637876	T 101 B - HCS, ground teeth and taper ground softwood, chipboard, wood core plywood, fibre boards (3-30 mm), plastics/epoxy (diameter <30 mm)	100	100	4964.82
2608630014	T 101 B - HCS, ground teeth and taper ground softwood, chipboard, wood core plywood, fibre boards (3-30 mm), plastics/epoxy (diameter <30 mm)	100	5	294.86
2608630032	T 101 D - HCS, ground teeth and taper ground softwood, chipboards, wood core plywood, fibre boards (10-45 mm)	100	5	306.90
2608637877	T 101 D - HCS, ground teeth and taper ground softwood, chipboards, wood core plywood, fibre boards (10-45 mm)	100	100	4945.46

2608637590	T 301 CD - HCS, ground teeth and taper ground softwood, chipboards, wood core plywood, fibre boards (10-65 mm)	117	5	391.55
------------	---	-----	---	--------

JIGSAW BLADES Progressor for Wood & Metal



Part Number	Description	Total Length mm	Pack Qty	List Price ₹
2609256737	T 345 XF Progressor for Wood and Metal Jigsaw Blade delivers fast straight cuts in thin and thick wood with metal	132	1	152.67
2608634994	T 345 XF - BIM, side set, milled construction timber with nails (<65 mm), wooden materials, plastics, sheet metals, pipes/profiles, including aluminium (diameter 3-10 mm)	132	5	846.02

JIGSAW BLADES Basic for Metal



Part Number	Description	Total Length mm	Pack Qty	List Price ₹
2609256729	T 118 A Basic for Metal Jigsaw Blade makes straight cuts in metal	92	1	117.49
2608631012	T 118 G - HSS, wavy set, milled very thin sheet metals (0.5 - 1.5 mm)	92	5	288.14
2608631013	T 118 A - HSS, wavy set, milled thin sheet metals (1-3 mm)	92	5	175.43
2608631964	T 118 A - HSS, wavy set, milled thin sheet metals (1-3 mm)	92	100	3277.30
2608631032	T 218 A - HSS, wavy set, milled thin sheet metals (1-3 mm), especially for curve cuts	92	5	272.22
2608631706	T 218 A - HSS, wavy set, milled thin sheet metals (1-3 mm), especially for curve cuts	92	100	3815.19
2608631319	T 318 A - HSS, wavy set, milled thin sheet metals (1-3 mm), pipes + profiles, including aluminium (diameter <65 mm)	132	5	313.69
2608631014	T 118 B - HSS, wavy set, milled medium-thick sheet metals (2.5-6 mm)	92	5	175.81
2608631965	T 118 B - HSS, wavy set, milled medium-thick sheet metals (2.5-6 mm)	92	100	3631.59
2608631404	T 318 B - HSS, wavy set, milled medium-thick sheet metals (2.5-6 mm), pipes + profiles, including aluminium (diameter <65 mm), precise angle cut	132	5	336.05

JIGSAW BLADES Flexible for Metal



Part Number	Description	Total Length mm	Pack Qty	List Price ₹
2608634505	T 118 AF - BIM, wavy set, milled thin sheet metals, perforated sheet metals (1-3 mm)	92	5	209.45
2608634774	T 118 AF - BIM, wavy set, milled thin sheet metals, perforated sheet metals (1-3 mm)	92	100	3886.54
2608634237	T 118 EOF - BIM, wavy set, milled thin sheet metals, perforated sheet metals (1.5-4 mm), especially for curve cuts	83	5	877.07
2608634503	T 118 BF - BIM, wavy set, milled medium-thick sheet metals, perforated sheet metals (2.5-6 mm)	92	5	330.45

JIGSAW BLADES Progressor for Metal



Part Number	Description	Total Length mm	Pack Qty	List Price ₹
2608638473	T 123 X - HSS, side set, milled thin to thick sheet metals (1.5-10 mm), pipes + profiles, including aluminium (diameter <30 mm)	100	5	307.67
2608638474	T 123 X - HSS, side set, milled thin to thick sheet metals (1.5-10 mm), pipes + profiles, including aluminium (diameter <30 mm)	100	25	1476.59

JIGSAW BLADES Special for Aluminium



Part Number	Description	Total Length mm	Pack Qty	List Price ₹
2609256736	T 127 D Special for Aluminium Jigsaw Blade delivers fast straight cuts in metal	100	2	120.49
2608631017	T 127 D - HSS, side set, milled thin to thick sheet metals (3-15 mm), pipes + profiles, (diameter <30 mm)	100	5	206.81
2608631966	T 127 D - HSS, side set, milled thin to thick sheet metals (3-15 mm), pipes + profiles, (diameter <30 mm)	100	100	3812.21
2608631030	T 227 D - HSS, side set, milled thin to thick sheet metals (3-15 mm), pipes + profiles (diameter <30 mm), especially for curve cuts	100	5	267.82
2608638382	T 227 D - HSS, side set, milled thin to thick sheet metals (3-15 mm), pipes + profiles (diameter <30 mm), especially for curve cuts	100	100	6124.84

JIGSAW BLADES Special for Acrylic



Part Number	Description	Total Length mm	Pack Qty	List Price ₹
2608631010	T 101 A - HSS, ground teeth and taper ground Perspex, polycarbonate (2-20 mm)	100	5	444.17

MIXED SETS



Pick and Click

Pick your accessory and click it in



HSS PointTeQ with Hex Shank

High speed drill

While keeping expected drill bit durability

1/4" HEX shank

135° split point tip design for quick start and perfect entering

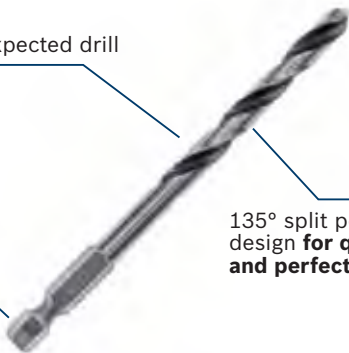

Colour ring SDB now with magnetic

S2 material and with magnetic

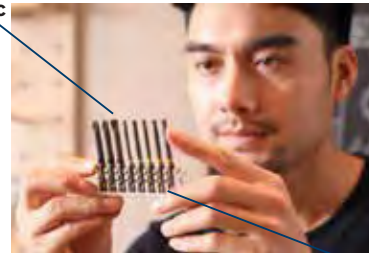

Tip size easily recognized

Easy pick and click indexes

Easy click: Allows clips to be easily installed or removed from case

Easier Tilt-in / Tilt-out Mechanism



Customizable Clip
Allows user to buy exactly the bits needed for the job

Customized and robust case

Clear cover
Provides ability to see bits inside case

Robust case
Rubber bumpers for tough environment



Secure close
Strong latch keeps bits safely stored in case

44 PCS MIXED SCREWDRIVER BITS SET



20 PCS MIXED DRILL AND DRIVE SET



Part Number	Description	Pack Quantity	List Price ₹
2608522421	44pcs mixed screwdriver bits set	1	1531.71

Part Number	Description	Pack Quantity	List Price ₹
2608522422	20pcs mixed drill and drive set	1	1419.34

X-34 Ti Mixed Set

34 pieces

NEW!



Part No.: 2607010608

List Price: ₹ 575.77

Consists of:

- ▶ 5 HSS metal drill bits, Ø 2-5 mm
- ▶ 5 masonry drill bits, Ø 5-8 mm
- ▶ 5 wood drill bits, Ø 4-8 mm
- ▶ 13 screwdriver bits L = 25 mm
- ▶ PH 1/2/3
- ▶ PZ 1/2/3
- ▶ S 4/6/7
- ▶ T 15/20/25/30
- ▶ 3 nutsetters, Ø 7/8/10 mm
- ▶ 1 adapter for nutsetters
- ▶ 1 universal holder, magnetic
- ▶ 1 countersink
- ▶ Dimensions (lxwxh): 172 x 46 x 164



Bosch DIY Starter Kit

73 pieces

NEW!



Part No.: 2607011660

List Price: ₹ 2246.43

Consists of:

- ▶ 1 Cutter Knife
- ▶ 1 Combination pliers
- ▶ 1 Hammer
- ▶ 1 Measuring Tape
- ▶ 1 Hand Screwdriver
- ▶ 1 Magnetic bit holder
- ▶ 1 Countersink
- ▶ 7 wood drill bits (3 / 4 / 5 / 6 / 7 / 8 / 10mm)
- ▶ 3 Metal drill Bits (3 / 4 / 6mm)
- ▶ 5 Masonry drill bits (4 / 5 / 6 / 8 / 10mm)
- ▶ 18 Screws (3 sizes)
- ▶ 18 Plastic plugs (3 sizes)
- ▶ 15 Screw Driver Bits (PH 1/2/2/3 , PZ 1/2/2/3, S 4/6/7, T 15,20,25,30)



MIXED SETS



Part Number	Description	Pack Quantity	List Price ₹
2607002790	108 pcs set	108	2137.82
2607002791	12 pcs set	12	1097.21
2607002792	66 pcs set	66	1672.24

NEW HANDTOOL SETS



Part Number	Description	Pack Quantity	List Price ₹
2607017540	11 pcs screwdriver bits set for IN	11	367.71
2607017542	12 pcs Multi-function mixed set, with ratcheting screwdriver, for IN	12	630.36
2607017543	14 pcs Multi-function mixed set, with ratcheting screwdriver, for IN	14	861.49
2607017544	15 pcs Multi-function mixed set for IN	15	893.01

HSS- R METAL DRILL BIT SETS



Part Number	Description	Pack Quantity	List Price ₹
2607019442	10-piece HSS-R metal drill bit set 10 HSS-R metal drill bits dia. 1 / 2 / 3 / 4 / 5 / 6 / 7 / 8 / 9 / 10 mm	10	611.10
2607019441	13-piece HSS-R metal drill bit set Ø 1.5 / 2 / 2.5 / 3 / 3.2 / 3.5 / 4 / 4.5 / 4.8 / 5 / 5.5 / 6 / 6.5 mm	13	519.09
2607019446	25-piece HSS-R metal drill bit set 1 / 1.5 / 2 / 2.5 / 3 / 3.5 / 4 / 4.5 / 5 / 5.5 / 6 / 6.5 / 7 / 7.5 / 8 / 8.5 / 9 / 9.5 / 10 / 10.5 / 11 / 11.5 / 12 / 12.5 / 13 mm	25	1914.11
2607019443	9-piece metal and masonry drill bit set 5 HSS-R metal drill bits, Ø 3/4/5/6/8 mm 4 masonry drill bits, Ø 4/5/6/8 mm	9	557.16

SCREWDRIVER BIT SETS



Part Number	Description	Pack Quantity	List Price ₹
2607017180	7-piece "Pocket" screwdriver bit set 6 screwdriver bits; L = 25 mm; PH 2; PZ 2; S 6; HEX 4 / 5; T 25; 1 hand screwdriver, ratchet function clockwise/ counter-clockwise	7	975.02
2607019454	10-piece screwdriver bit set 9 screwdriver bits L = 25 mm PH 1/2/3; PZ 1/2/3; S 4.5/5.5/8 1 universal holder, magnetic	10	605.25
2607019510	10-piece "Pocket" screwdriver bit set 9 screwdriver bits L = 25 mm PH 1/2, PZ 1/2/3, HEX 4 / 5, T 20/25 1 hand screwdriver, ratchet function clock- wise/counter-clockwise	10	365.35
2607019503	25-piece "Big Bit" screwdriver bit set, Lipstick Set 24 screwdriver bits, L=25 mm PH 1 / 1 / 2 / 2 / 3 / 3, 0 PZ 1 / 1 / 2 / 2 / 3 / 3, S 4 / 4 / 6 / 6 / 7 / 7, T 20/20/25/25/30/30 1 universal holder, magnetic	25	487.51
2607017322	26-piece screwdriver bit and ratchet set 19 screwdriver bits with colour coding L = 25 mm; PH 1/2/2/3; PZ 1/2/3; S 4/5/6; T 10/15/20/25/30; HEX 3/4/5/6; 4 nutsetters, width across flats: 6/8/10/13 mm 1 ratchet (clockwise/counter-clockwise) 1 universal holder, magnetic 1 adapter for nutsetters	26	1741.13
2607017201	27-piece drill and screwdriver bit set 1 x Top for Wood S 1131 L 1 x Progressor for Wood S 2345 X 1 x Progressor for Wood and Metal S 3456 XF	27	986.63
2607019506	38 pcs Mixed Set 23 screwdriver bits, L=25 mm PH 0/1/1/2/2/3, PZ 0/1/1/2/2/3, S 4/6/7, HEX 3/4/5/6, T 15/20/25/40 7 nutsetters, Ø 5/6/7/8/10/11/13 mm 4 hex keys 3/4/5/6 mm 1 universal holder, magnetic 1 torch, 1 hand screwdriver, ratchet function clockwise/counter-clockwise 1 adapter for nutsetters	38	1102.71

SCREWDRIVER BIT SETS



Part Number	Description	Pack Quantity	List Price ₹
2607019504	46 pcs Screwdriver Set 32 screwdriver bits L = 30 mm PH 0/1/2/3, PZ 0/1/2/3, S 3/4/4.5/5/6/7/8/9, HEX 1.5/2/2.5/3/4/5/5.5/6, T 8/10/15/20/25/27/30/40 12 nutsetters for hex screws 3/16", 1/4", 5/16", 11/32", 3/8", 7/16", 6, 7, 8, 10, 11, 13 mm 1 universal holder, magnetic 1 hand screwdriver, ratchet function clockwise/counter-clockwise Bit garage in the handle	46	1700.91

20 PCS PICK AND CLICK METAL DRILL AND DRIVE SET

NEW!



Part Number	Description	Pack Quantity	List Price ₹
2608522422	20 pcs Mixed Drill and Drive set 4 x 25mm Insert Bits (PH 1/2/2/3); 1 x 25mm Insert Bits (PZ 2); 2 x 25mm Insert Bits (SL 4/6); 2 x 25mm Insert Bits (HEX 5/6); 3 x 25mm Insert Bits (T 15/20/25); 4 x 65mm Power Bits (PH2, S6, H3, H4) 1 x Bits Holder (55.5mm) 3 x HSS PointTeQ (4/5/6mm)	20	1419.34

44 PCS PICK AND CLICK METAL DRILL AND DRIVE SET

NEW!



Part Number	Description	Pack Quantity	List Price ₹
2608522421	44 pcs Mixed Screwdriver bits set 25mm: SDB PH1/2/2/3; PZ1/2/2/3; SL3/4/5/6; HEX: 3/4/5/6; T10/15/20/25/27/30/40; TH10/15/20/25/27/30/40 65mm: power bits PH2; PZ2; SL6; T15/20/25; H3/4 Nutsetter: 6/8/10; quick change bits holder 1 pcs	44	1531.71

X LINE TITANIUM SETS



Part Number	Description	Std Pack	List Price ₹
2607019324	30-piece X-Line Titanium set 11 HSS-TiN metal bits, dia. 1.5-6.5 mm; 4 TC masonry drill bits, dia. 4/5/6/7 mm; 4 wood drill bits, dia. 4/5/6/8 mm; 10 screwdriver bits, L = 25 mm, H1/2/3, PZ 1/2/3, L 4/6T 20/25; Magnetic universal holder; countersink bit	30	748.54

2607019327	50-piece X-Line Titanium set 11 HSS-TiN metal drill bits, Ø 1.5-6.5 mm 6 masonry drill bits, Ø 4-10 mm 5 wood drill bits, Ø 4-10 mm 2 spade bits, Titanium, Ø 16/22 mm 18 screwdriver bits, L=25 mm PH 1/2/2/3, PZ 1/2/2/3, S 4/6/7, HEX 3/4/5/6, T 15/20/25 3 nutsetters, Ø 7/8/10 mm, 1 adapter for nutsetters 1 diameter gauge, 1 knife, 1 universal holder, magnetic 1 countersink	50	1467.13
------------	--	----	---------

2607019328	65-piece X-Line set 39 screwdriver bits: Titanium • L = 25 mm PH 0/1/2/3, PZ 0/1/2/3, S 4/6/7, T 10/10/15/15/20/20/25/30/40, Hex 3/4/5/6 10 screwdriver bits: Titanium • L = 50 mm PH 0/1/2/3, PZ 0/1/2/3, S 4/6 12 socket wrenches for hex screws 6, 1/," , 7, 9/32", 8. 5/16", 9, 11/32", 10, 3/8", 13, 1/2" 1 universal holder, magnetic 1 socket wrench adapter • L = 25 mm 1 hand screwdriver (right/left rotation) Extension shank • flexible	65	1970.51
------------	---	----	---------



Bosch Limited, Power Tools Division

PA-AT Complex, Hosur Road, Adugodi,
Bangalore - 560030

 www.facebook.com/BoschPTIndia



Customer Contact Center
1800 425 8665

Email: bosch.accessories@in.bosch.com
www.bosch-pt.co.in